

SPECIFICATIONS

GENERAL

Standards
IMO A.694(17), IMO MSC.74(69) Annex 3,
IEC 60993-2, ITU-R M.1371-1, ITU-R M.825-3(DSC)

Ship reporting capacity
2250 reports per minute, 4500 reports per minute on two channels

TRANSPONDER UNIT

TX/RX Frequency 156.025 MHz to 162.025 MHz
RX1: Default CH87B (161.975 MHz)
RX2: Default CH88B (162.025 MHz)
Output Power 2 W/ 12.5 W selectable
DSC Receiver CH70 fixed, 156.525 MHz, G2B, 1200 bps
Bandwidth 25 kHz/ 12.5 kHz

DISPLAY UNIT

Screen Size 4.5" monochrome LCD
Effective Viewing Area 95 (H) x 60 (V) mm
Pixel Number 120 (H) x 64 (V)

GPS RECEIVER

Receiving Channels 12 channels parallel, 12 satellites tracking
Rx Frequency/Rx Code 1575.42 MHz, C/A code
Position Fixing System All in view, 8-state Kalman filter
Position Accuracy 10 m (HDOP ≤ 4)

INTERFACE

COM 1 - 4* IEC 61162-1/61162-2
Input: VSD, SSD, ABM, BBM, ACA, ACK, AIR, DTM, GBS, GGA, GLL, GNS, HDT, LRF, LRI, OSD, RMC, ROT, VBW, VTG, VDM, VDO, ABK, ACA, ALR, TXT, LR1, LR2, LR3, LRF, LRI
Output:

*Note: COM 4 also functions as SENSOR input

SENSOR (input) IEC 61162-1/61162-2

COM 4 - 6

Input: DTM, GNS, GLL, GGA, RMC, VBW, VTG, OSD, HDT, GBS, ROT

AD-10 AD-10 format (FURUNO gyro format)

External Beacon RS-232C

PC RS-232C

Alarm Output 10/100 Base-T Ethernet (Option)
Contact closure

POWER SUPPLY

Transponder Unit 12-24 VDC: 7-3.5 A
Display Unit 12-24 VDC: 0.3-0.15 A
AC/DC Power Supply Unit PR-240 (option):
100/110/200/220 VAC, 1 Ø, 50/60 Hz

ENVIRONMENT

Temperature
GPS Antenna Unit -25°C to +70°C
Other Units -15°C to +55°C

Waterproofing (IEC 60529)

Antenna Unit IPX6

Vibration (IEC 60945 ed.4)

EQUIPMENT LIST

Standard

1. Transponder Unit FA-1501 1 unit
2. Display Unit FA-1502 1 unit
3. GPS Antenna Unit GSC-001-E, GPA-017S-E or GPS/VHF Combined Antenna Unit GVA-100 with Distribution Box DB-1 1 unit
4. Installation Materials 1 set

Option

1. VHF Antenna Unit 150M-W2VN with bracket
2. Antenna Cable Kit
For GPS/VHF Combined Antenna GVA-100
OP24-00300: 30 m, OP24-00310: 50 m
For GSC-001 and GPA-017S
TNC-PS-3D-15: 15 m, CP-20-02700: 30 m, CP-20-02710: 50 m
3. Antenna Base
CP20-01111: Pipe mount, No. 13-QA310: Offset bracket,
No. 13-QA330: Deck mount, No. 13-RC5160: Handrail mount
4. Cable between Display and Transponder Unit
MJ-A10SPF0012-050/100/250/500/1000: 5/10/25/50/100 m
5. Flush Mount Kit OP20-29: F type, OP20-17: S type
6. Pilot Plug OP24-3
7. Software for PC
8. Power Supply Unit PR-240
9. LAN Interface for PC

Note: IMO requires that the AIS operate on ship's mains (115/230 VAC) and alternative power source, then a PR-240 is required. Check with your authorities for alternative power as it can be an emergency source (AC generator) or reserve source (batteries).

INTERCONNECTION DIAGRAM

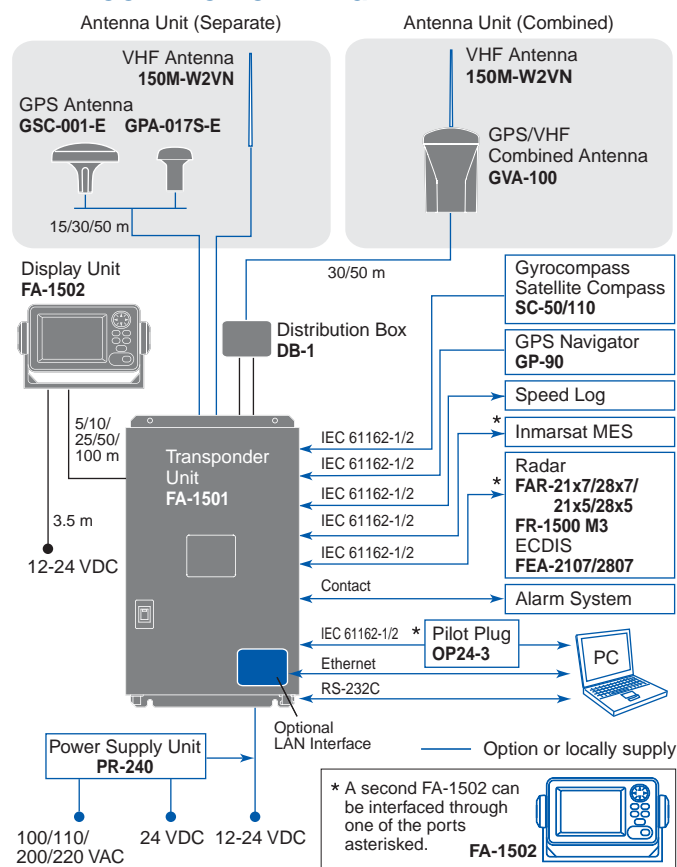

Transponder Unit

FA-1501 7.3 kg, 16.1 lb

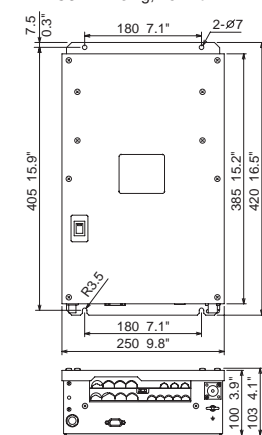

Display Unit

FA-1502 0.6 kg, 1.3 lb

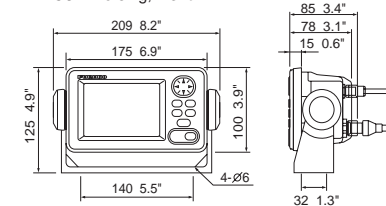

GPS Antenna

GSC-001-E 0.5 kg, 1.1 lb

GPA-017S-E 0.15 kg, 0.3 lb

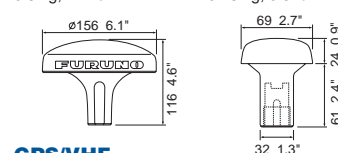

GPS/VHF Combined Antenna

GVA-100 3.3 kg, 7.3 lb

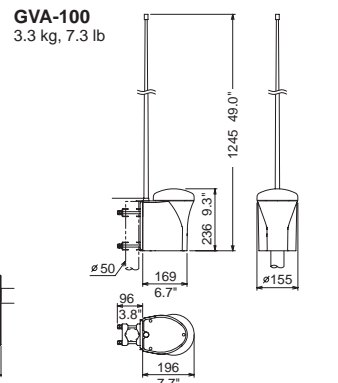

Distribution Box

DB-1 0.9 kg, 2.0 lb

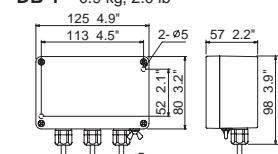

Pilot Plug (Option)

OP24-3 0.6 kg, 1.3 lb

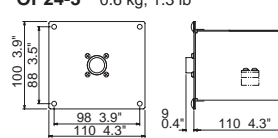

TRADE MARK REGISTERED MARCA REGISTRADA
SPECIFICATIONS SUBJECT TO CHANGE WITHOUT NOTICE

FURUNO U.S.A., INC.

Camas, Washington, U.S.A.
Phone: +1 360-834-9300
Fax: +1 360-834-9400

FURUNO (UK) LIMITED

Havant, Hampshire, U.K.
Phone: +44 2392-441100
Fax: +44 2392-484316

FURUNO FRANCE S.A.

Bordeaux-Mérignac, France
Phone: +33 5 56 13 48 00
Fax: +33 5 56 13 48 01

FURUNO ESPAÑA S.A.

Madrid, Spain
Phone: +34 91-725-90-88
Fax: +34 91-725-98-97

FURUNO DANMARK AS

Hvidovre, Denmark
Phone: +45 36 77 45 00
Fax: +45 36 77 45 01

FURUNO NORGE A/S

Ålesund, Norway
Phone: +47 70 102950
Fax: +47 70 102951

FURUNO SVERIGE AB

Västra Frölunda, Sweden
Phone: +46 31-7098940
Fax: +46 31-497093

FURUNO FINLAND OY

Espoo, Finland
Phone: +358 9 4355 670
Fax: +358 9 4355 6710

FURUNO POLSKA Sp. z o.o.

Gdynia, Poland
Phone: +48 58 669 02 20
Fax: +48 58 669 02 21

FURUNO DEUTSCHLAND GmbH

Rellingen, Germany
Phone: +49 4101 838 0
Fax: +49 4101 838 111

LLC "FURUNO EURUS"

St. Petersburg, Russian Federation
Phone: +7 812 767 15 92
Fax: +7 812 766 55 52

PRINTED WITH SOYINK 0708XSS Printed in Japan

GEOMETRA INTERNATIONAL (PRIVATE) LIMITED
LAND AND HYDROGRAPHIC SURVEYS

71 Ubi Crescent Tel: (65) 6743 7262
#02-10 Excalibur Centre Fax: (65) 6746 1941
Singapore 408571 Email: geometra@pacific.net.sg
RCB No.: 197800432Z Website: http://www.geometra.com.sg

ISO 9001:2007

ISO 9001:2000



The future today with FURUNO's electronics technology.

FURUNO ELECTRIC CO., LTD.

9-52 Ashihara-cho, Nishinomiya City, Japan Phone: +81 (0)798 65-2111
Fax: +81 (0)798 65-4200, 66-4622 URL: www.furuno.co.jp

Catalogue No. N-864b

TRADE MARK REGISTERED
MARCA REGISTRADA

FURUNO offers reliable AIS performance for safe navigation

A Class-A Universal Automatic Identification System (UAIS) transponder, the FA-150 is designed to improve navigation safety by observing other AIS equipped ships. The FA-150 complies with relevant international regulations and standards (e.g., IMO, ITU-R, IEC) as well as national class requirements.

The FA-150 offers real-time information exchange of your own ships data and other AIS-equipped ships or coastal stations within VHF coverage. Information that is exchanged includes static, dynamic, voyage related data, as well as short safety-related messages.

The FA-150 consists of a GPS antenna, a transponder unit, a display unit and other associated equipment. The internal GPS receiver provides UTC reference for system

synchronization. It also gives position, COG and SOG if no external positioning equipment is connected. There are two types of configurations for the antenna unit: GPS and VHF combined and separate antennas. Both types of GPS antennas feature a special interference shield that allows superior performance when they are in an area of influence by equipment such as radar and satellite phones. An exceptionally compact GPS antenna is also available in the separate configuration.

The FA-150 can be interfaced with Radar and ECDIS, allowing AIS information to be displayed on them.

No additional interface units are required for connection to the latest FURUNO radar FAR-21x7/28x7 series or ECDIS FEA-2107/2807 series. Use of the WAGO connectors simplifies installation and connection.



Automatic Identification System
FA-150

- ▶ Compact 4.5" silver bright display
- ▶ Full compliance with international regulations and standards
 - IMO MSC.74(69) Annex 3 • ITU-R M.1371 • IEC 60993-2
 - IEC 60945 • MTSA 2002 - U.S. AIS Requirements
- ▶ Integrates with Radar, ECDIS and Electronic Chart System
- ▶ Easy to operate
- ▶ Optional PC software
- ▶ Provides real-time AIS info for collision avoidance

[TARGET LIST]

NAME	RNG (nm)	BRG (°)
FURUNO3	4.28	229.8
FURUNO4	4.58	235.2
FURUNO5	4.73	229.0
FURUNO6	4.91	222.9
FURUNO7	5.05	224.2

Target list

[FURUNO123]

HOG: 118°
SOG: 12.7 kts
COG: 116.8°
CPA: 7.17 nm
TCPA: 4'07"
INTRO: 0
DETAIL: CENT

Plotter

[ALARM STATUS]

EPFS 10/AUG 02:09:48
HOG 10/AUG 02:09:48
ROT 10/AUG 02:09:48

Alarm status

[OWN DYNAMIC DATA]

10/AUG/2004 03:39:37
LAT: 34°44.4683'N
LON: 135°21.2682'E
SOG: 15.2 kts INT GPS
COG: 237.6° HDG: ---°
ROT: ---°/min
PA: L RAIN: UNUSE

Own dynamic data

[OWN STATIC DATA] 1/5

NAME : FURUNO7
CALL SIGN: **-***
MMSI : 000000000
IMO No. : *****

Own static data



Separate GPS antennas



Combined antenna

AIS enhances detection of other ships and Aids to Navigation on radar and ECDIS units.

- ▶ AIS targets are visible even if they are behind large ships, islands or other landmasses
- ▶ AIS targets are not obscured by sea clutter and rain clutter
- ▶ ROT display at tip of COG/SOG vector allows navigators to predict course changes of other vessels



AIS COG/SOG vector changes its length with speed and a ROT mark is viewable at the COG/SOG vector tip when a target ship is equipped with a FURUNO satellite compass SC-50/110 or other compatible equipment.

FEA-2107: 20.1" LCD
FEA-2807: 23.1" LCD

FAR-21x7 series: 20.1" LCD
FAR-28x7 series: 23.1" LCD

PC software

(Available in autumn 2005)

Optional PC software is available to facilitate comprehensive observation of AIS information. With this software application, chart overlay*, target information and targets list can be displayed on one display. *Requires chart data

AIS features include:

- ▶ Provides real-time AIS information for collision avoidance
- ▶ A means for coastal stations to obtain information about a ship and its cargo
- ▶ VTS tool, i.e., ship-to-shore traffic management

Information to be exchanged

- ▶ **Static Data**
 - MMSI (Maritime Mobile Service Identity)
 - IMO number (Where available)
 - Call sign & name
 - Length and beam
 - Type of ship
 - Location of position-fixing antenna on the ship
- ▶ **Dynamic data**
 - Ship's position with accuracy indication and integrity status
 - Coordinated universal time (UTC)
 - Course over ground (COG)
 - Speed over ground (SOG)
 - Heading
 - Navigation status (manual input)
 - Rate of turn (where available)
 - Update rates Dependent on speed and course alteration (2 s – 3 min)
- ▶ **Voyage related data**
 - Ship's draft
 - Hazardous cargo (type)
 - Destination and ETA (at masters discretion)
- ▶ **Short safety-related messages**
 - Free messages

Implementation schedule

(MSC.73 adopted on 5 December 2001 and Amendments adopted on 13 December 2002 by the Conference of Contracting Governments to the SOLAS 1974)

New build	All ships of ≥300 GT on international voyages	
	Cargo ships ≥500 GT not on international voyages	Before 1 July 2008
	Passenger ships irrespective of size on all voyages	
Ships not on international voyages constructed before 1 July 2002	Passenger ships	Before 1 July 2008
	Ships, other than passenger ≥500 GT	

NOTE: All vessels in U.S. waters - Complies with MTSA 2002 (Maritime Transportation Security Act) U.S. AIS Requirements